

SDC-150A diode driver

User manual

Important note. Please measure output with adequate load only (diodes). Resistive load connected to the output won't destroy the driver, but will severe distort its behavior.

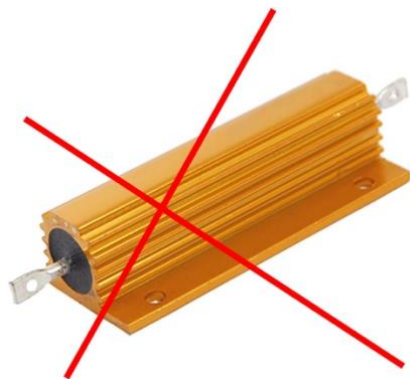

Description

SDC-150A is 'all-in-one' DPSS Nd:YAG controller which includes a pulsed current source to drive pumping diodes, TEC controller for their thermal stabilization and embedded Pockels cell driver for generation of Q-switched pulses. Driver's input is 28 V DC (+/-7 V).

Driver's major features are:

- 28 V DC (+/-7 V) input
- Diode output – up to 150 A, 25 V, 300 us, 30 Hz (but 20 W max) *
- TEC output – up to 5 A, 20 V (but 50 W max) *
- Pockels cell driver – SDC-150A can be equipped with Pockels cell driver of two different modifications on customer's choice, one for DKDP cells, the other for LiNbO3 cells

**) Other parameters are available on request. See also How to order? section.*

Base interface is RS-232 (RS-485 is available as an option). Simple PC software is supplied together with the controller.

The cooling, when needed, is performed through the heatsink attached to the bottom surface.

Appearance

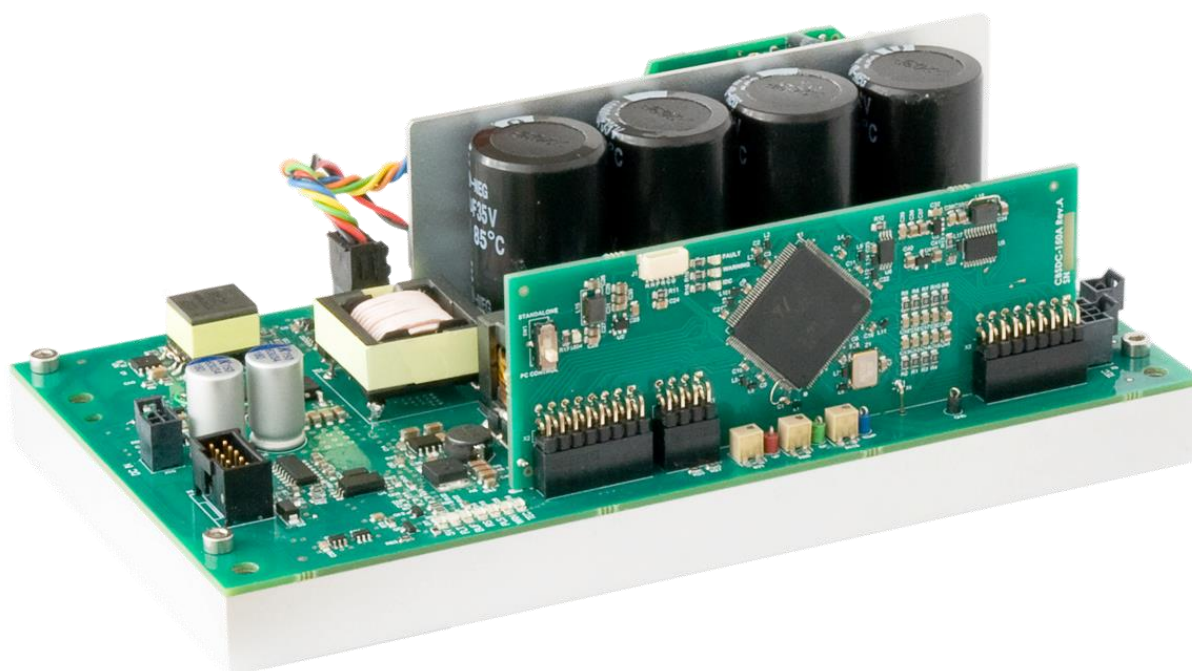

Connections, signals, signal descriptions

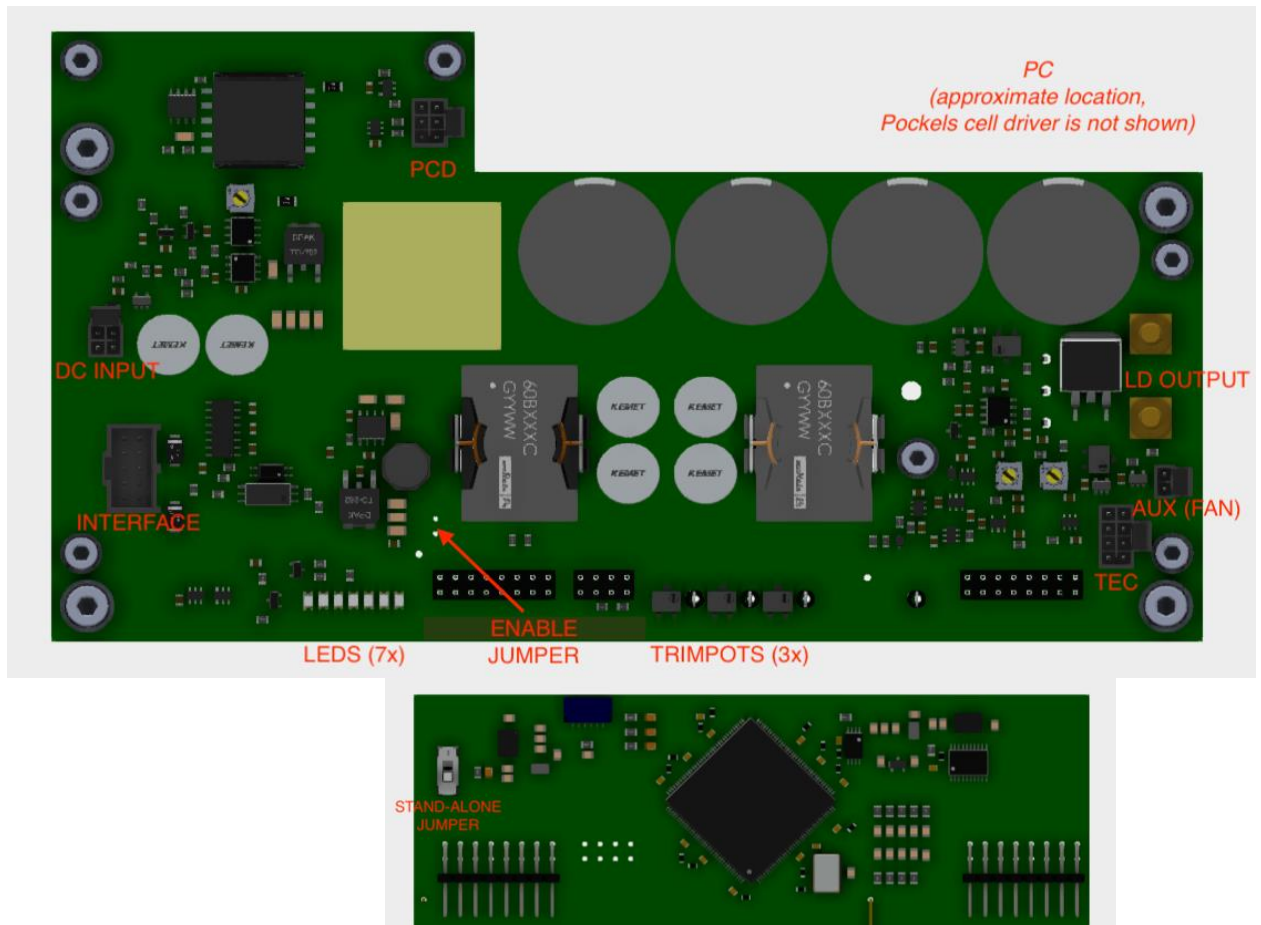

TYPE	DESIGNATION	DESCRIPTION
Connector	DC INPUT	Power input (28 V DC nominal)
Connector	INTERFACE	RS-232 (RS-485) interface Synchro input, synchro output, other analogue signals
Screw terminal	LD OUTPUT	Pulsed output to the laser diode
Connector	TEC	Peltier and NTC connection, aux. NTC connection
Connector	PC	Pockels cell connection (high voltage output of SDC-150A)
Connector	PCD	Pockels cell driver connection (interconnection within SDC-150A)
Connector	AUX (FAN)	Auxiliary 12 V DC output (e.g. can be used to power up the fan)
Jumper	STAND-ALONE JUMPER	Defines the way output current and diode temperature are set

Trimpot	VOLTAGE TRIMPOT	Sets buffer voltage if <i>STAND-ALONE JUMPER</i> is on
Trimpot	CURRENT TRIMPOT	Sets output current if <i>STAND-ALONE JUMPER</i> is on
Trimpot	TEMP TRIMPOT	Sets diode temperature if <i>STAND-ALONE JUMPER</i> is on
Jumper	ENABLE JUMPER	Enables driver's outputs in Stand-alone mode of operations
LED	STATUS LEDES	A number of LEDs depicting driver's status

DC INPUT: Molex Nano-Fit (105310-1204)

Input supply voltage (28VDC nominal) is to be connected here.

PIN (color)	DESIGNATION	DESCRIPTION
1, 2 (black)	GND	Input supply voltage (28 V DC +/- 7 V) is to be connected here.
3, 4 (red)	V_{IN}	

INTERFACE: 10 pin Molex C-Grid III connector (90130-1210)

INTERFACE connector provides both digital and analogue interfaces to the driver.

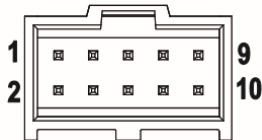

RS-232 modification of the driver:

PIN (color)	DESIGNATION	DESCRIPTION
1 (violet)	RS-232 TX	The control device connection (RS-232 interface).
2 (blue)	RS-232 GND	
3 (orange)	RS-232 RX	
4 (green)	IDC	Door-interlock connection. Should be pulled to the ground to allow the operations.
5 (yellow)	Synchro OUT	Synchro output signal (1ms pulse length, adjustable delay relatively to the current pulse)

6 (white)	Synchro IN	Incoming synchronization pulses should be applied to this pin if module is running in external synchronization mode. Input impedance is approx. 1.6 kOhm
7 (red)	Fault	Module internal failure indication. Module rises Fault in the next cases: <ul style="list-style-type: none"> - Overheating - Unable to charge buffer capacitors - Unable to stabilize the temperature - Other failures
8 (black)	Interface Return	Common return of all interface circuits

RS-485 modification difference (other signals are identical to RS-232 modification):

PIN (color)	DESIGNATION	DESCRIPTION
1 (violet)	RS-485 B	The control device connection (RS-485 interface).
2 (blue)	N/C	
3 (orange)	RS-485 A	

INTERFACE circuits schematics:

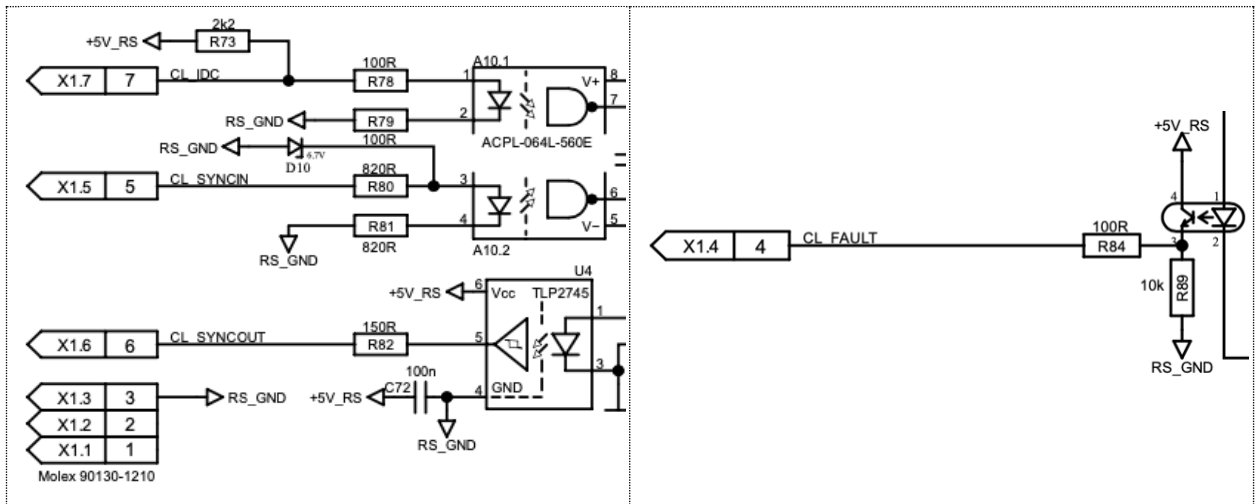

LD OUTPUT: M4 thread (2pcs)

Output to the laser diode.

TEC: Molex Nano-Fit (105310-1208)



PIN (color)	DESIGNATION	DESCRIPTION
1, 2 (black)	TEC-	Peltier connection (negative). Both pins are interconnected in parallel.
3, 7 (violet)	NTC	10 kOhm NTC connection
4, 8 (blue)	NTC-AUX	Reserved for future use
5, 6 (red)	TEC+	Peltier connection (positive). Both pins are interconnected in parallel.

PC: Proprietary connector by OEM Tech

Pockels cell is to be connected here.

Red wire – HV output positive

Blue wire – HV output negative

PCD: Molex Nano-Fit (105310-1206)

PIN (color)	DESIGNATION	DESCRIPTION
1 (red)	V _{IN}	See also user manual for the relevant Pockels cell driver. Pulse signal (pin 2) applied to the Pockels cell driver has fixed 100 us pulse length and adjustable delay relatively to the current pulse
2 (orange)	Pulse	
3 (green)	Voltage Program	
4 (black)	GND	
5 (blue)	Enable	
6 (yellow)	Voltage Monitor	

AUX (FAN): Molex Nano-Fit (105310-1202)

PIN (color)	DESIGNATION	DESCRIPTION
1 (black)	GND	12 V DC auxiliary output
2 (red)	12VDC	

Jumpers, trimpots, LEDs

STAND-ALONE JUMPER. When *STAND-ALONE JUMPER* is ON, SDC-150A doesn't need active RS-232 connection to operate and works as a stand-alone device. In this case the output parameters are set either from memory or by *VOLTAGE TRIMPOT*, *CURRENT TRIMPOT* and *TEMP TRIMPOT* (see also *Modes of operations* section).

VOLTAGE TRIMPOT, CURRENT TRIMPOT, TEMP TRIMPOT. When *STAND-ALONE JUMPER* is ON and parameters are set accordingly to trimpots (see also software description), *VOLTAGE TRIMPOT* defines buffer voltage, *CURRENT TRIMPOT* defines output pulse current and *TEMP TRIMPOT* defines the TEC set point.

ENABLE JUMPER. Enables all driver's outputs in Stand-alone regime of operations.

STATUS LEDs. There are several LEDs indicating state of SDC-150A board.

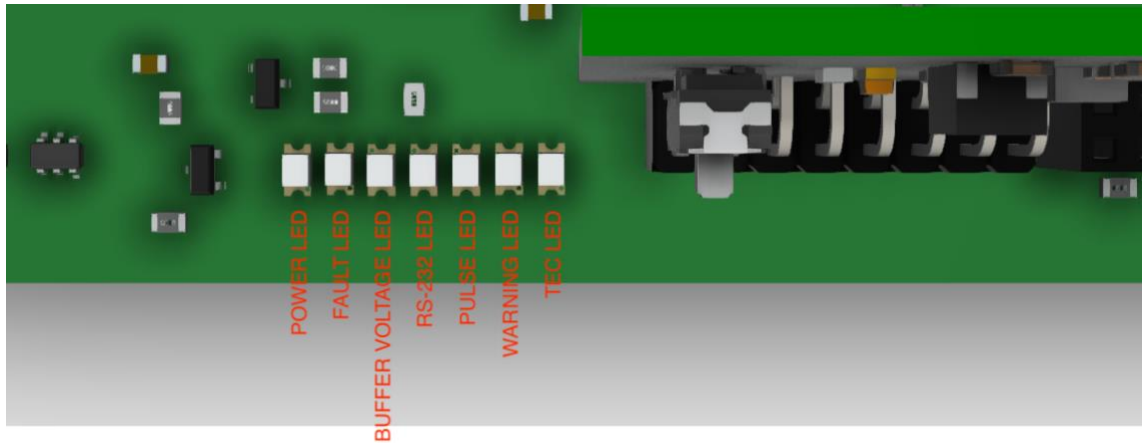

POWER LED (green):

- lights steadily once DC power is applied to the driver

RS-232 LED (blue):

- blinks when the device sends data via RS-232 interface

BUFFER VOLTAGE LED (green):

- lights steadily if buffer voltage power supply is enabled and works properly

WARNING (orange):

- blinks if buffer voltage is too low to obtain the desired output current

PULSE LED (green):

- blinks synchronously with synchronization pulses (coming either from external or from internal pulse generator)

TEC LED (green):

- blinks if TEC is turned on and thermal stabilization is not achieved
- lights steadily if TEC is turned on and thermal stabilization is achieved

FAULT LED (red):

- lights steadily if any of Fault conditions is met at the moment



FAULT LED (red):

- lights steadily if any of Fault conditions has been met
- FAULT LED and IDC LED light together when IDC circuit is opened
- FAULT LED and WARNING LED light together when in Stand-alone mode driver is powered with *ENABLE JUMPER* already set ON (this is considered as a fault condition and requires disabling driver with *ENABLE JUMPER* and enabling it again)

WARNING (yellow):

- also indicates mode of operations – high frequency blinking (approx. 2 Hz) in Stand-alone mode and low frequency blinking (approx. 1 Hz) in RS-232 mode

Mounting and grounding

Driver should be mounted using four M4 screws.

Grounding policy

Most of SDC-150A circuits have common ground. Only INTERFACE signals (both digital and analogue) are optically isolated from other circuits.

Modes of operations

RS-232 mode and Stand-alone mode

SDC-150A has two control modes – RS-232 mode и Stand-alone mode:

- RS-232 mode – requires the active RS-232 connection and all the controls are performed by commands sent via RS-232 interface. To operate in this mode *STAND-ALONE JUMPER* should be set to OFF position.
- Stand-Alone mode – doesn't require the active RS-232 connection and SDC-150A starts operations immediately after DC power is applied to the board. To operate in this mode *STAND-ALONE JUMPER* should be set to ON position.

Switching between RS-232 mode and Stand-alone mode is not trivial. Please follow the instructions below.

RS-232 mode to Stand-alone mode

1. Switch *STAND-ALONE JUMPER* to OFF position.
2. Apply power to SDC-150A.
3. Establish RS-232 connection between controlling device and SDC-150A.
Further description supposes, that SDC-150A is connected to PC and controlled via software, although the same can be done from customer's controlling device by sending RS-232 command.
4. Set "**I, V, T control in Stand-alone mode**" to "**Parameters from memory**" and set up the essential parameters and regimes of SDC-150A, e.g.:
 - 4.1. TEC temperature
 - 4.2. output current
 - 4.3. pulse width*Note: Similarly, "I, V, T control in Stand-alone mode" can be set to "Manual control"*
5. Save parameters with **SAVE TO EEPROM** button.
6. Remove power from SDC-150A.
7. Switch *STAND-ALONE JUMPER* to ON position.
8. Apply power to SDC-150A.
9. Set ON the *ENABLE JUMPER* – driver will operate with saved parameters.

Stand-alone mode to RS-232 mode

1. Remove power from SDC-150A board.
2. Switch *STAND-ALONE JUMPER* to OFF position.
3. Connect SDC-150A to the controlling device (PC or another one).
4. Apply power to SDC-150A.
5. Establish RS-232 connection between controlling device and SDC-150A.

Specifications

ELECTRICAL

DC INPUT:	
Input voltage	28 V DC +/- 7 V
Current consumption	5 A max
OUTPUT 1 (DIODE DRIVER):	
Description	Pulses delivered to the pumping diode
Load	Laser diode
Diode compliance voltage (V _{MAX})	25 V by default (other on request)
Maximum output current (I _{MAX})	150 A by default (other on request)
Note – maximum peak power (I _{MAX} * V _{MAX}) shouldn't exceed 10kW	
Output current (I)	10 ... 100 % of I _{MAX} adjustable
Accuracy	<1 % of I _{MAX}
Pulse width (t)	50 ... 300 us adjustable (other on request)
Pulse rise (fall) time	<50 us
Repetition rate (f)	1 ... 30 Hz adjustable (other on request)
Maximum output power (V*I*t*f)	>20 W by default (maximum parameters cannot be realized at the same time due to the maximum power limitation) >40 W on request (with derated operation temperature)
Target regime	150 A, 25 V, 250 us, 20 Hz (<20 W)
<p>Important note – since diode driver has no galvanic insulation between input and output:</p> <ul style="list-style-type: none"> • diode's anode will be under buffer voltage potential • diode's cathode will be under floating potential different from the ground potential • both diode's anode and cathode cannot be grounded in any way and must be isolated from the ground 	
OUTPUT 2 (TEC):	
Load	Peltiers
Maximum output current	5 A (other on request)
Maximum output voltage	20 V (other on request)
Stabilization temperature	+20 ... +60 °C adjustable
Accuracy	0.1 °C
Thermistor	10 kOhm NTC
OUTPUT 3 (POCKELS CELL DRIVER – DKDP VERSION):	
Load	DKDP Pockels cell

Load capacitance	5-7 pF
Pulse shape	Triangular (fast rise, relatively slow decay)
Rise time	<20 ns
Recovery time	5 us typically
Pulse amplitude	1600 ... 4000 V adjustable
Bias voltage	No
Other	Adjustable delay relatively to the diode driver
OUTPUT 3 (POCKELS CELL DRIVER – LiNbO3 VERSION):	
Load	LiNbO3 Pockels cell
Load capacitance	<20 pF
Pulse shape	Triangular (fast rise, relatively slow decay)
Rise time	<30 ns
Recovery time	5 us typically
Pulse amplitude	800 ... 2000 V adjustable (other on request)
Bias voltage	On request
Other	Adjustable delay relatively to the diode driver
Warning – Pockels cell's electrodes must be isolated from the ground and cannot be grounded in any way	
COOLING	Passive cooling through the cold-plate attached to the driver bottom; the customer's responsibility is to keep cold-plate temperature below 70 °C (e.g. by attaching cold-plate to the massive heatsink or to the system chassis)
PROTECTIONS	From overheating of internal components From short-circuit at the output From mismatched load at the output Interlock door connection
INTERFACES (DIGITAL)	RS-232 machine interface
INTERFACES (ANALOGUE)	<ul style="list-style-type: none"> • IDC • Fault • Synchro input • Synchro output
ENVIRONMENT:	
Operation temperature	Driver is designed for –30 ... +55 °C operating temperatures (we do our best to assure good performance in the required range of operating temperatures, though due to the absence of temperature chamber real testing in whole range of ambient temperatures is not performed by us)
Storage temperature	–40 ... +85 °C

Humidity	0 ... 90 %, non-condensing
Shock / vibration	No special requirements

MECHANICAL

Size (LxWxH)	190x110x60 mm (see also the dimensional drawing below)
Weight	<1.0 kg

How to order?

Modification	Description
SDC-150A or SDC-150A-25V	Base version: <ul style="list-style-type: none"> • 150 A maximum output current • 25 V maximum output voltage • Maximum output power >20 W (target regime 150 A, 25 V, 250 us, 20 Hz)
SDC-110A-85V	Customized version: <ul style="list-style-type: none"> • 110 A maximum output current • 85 V maximum output voltage • Maximum output power >20 W (target regime 110 A, 85 V, 220 us, 10 Hz)
SDC-110A-85V-HP	Customized version: <ul style="list-style-type: none"> • 110 A maximum output current • 85 V maximum output voltage • Boosted output power; achieved by the cost of narrowed operating temperature range • Maximum output power >40 W (target regime 110 A, 85 V, 220 us, 20 Hz) • Operation temperature 0-40 °C

DIMENSIONAL DRAWING

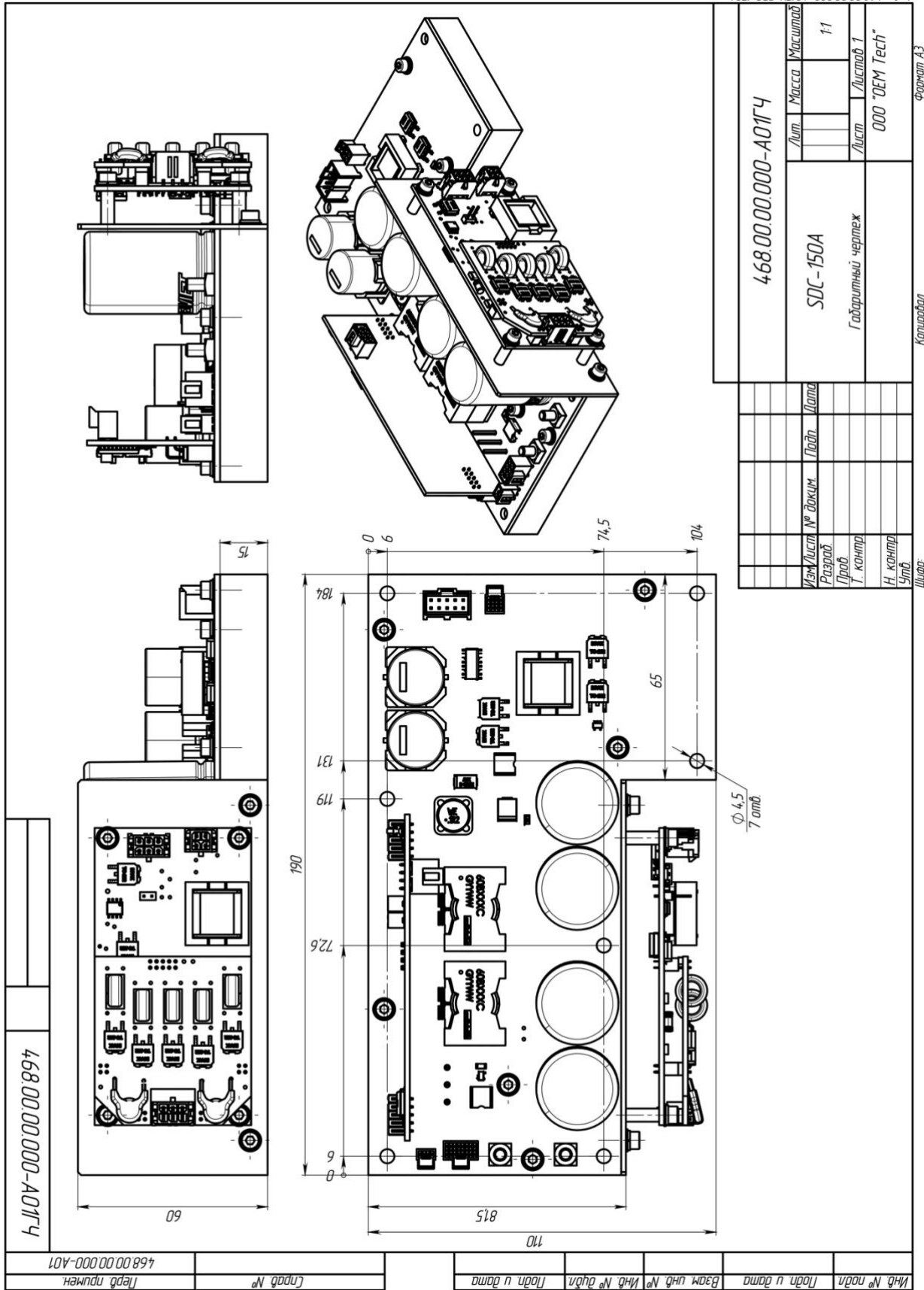

Software description

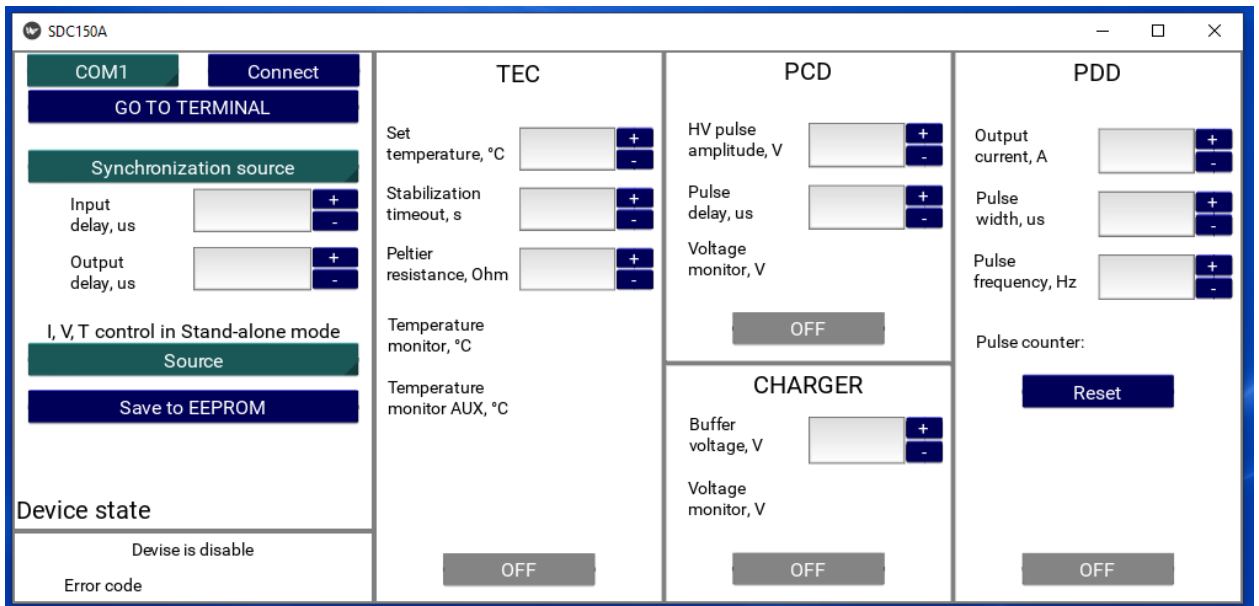

Parameters section:

- **COM list** – selects the COM port to connect the driver to
- **CONNECT** button – connects driver to the selected COM port
- **GO TO TERMINAL** button – runs terminal (to send textual commands to the driver)
- **SYNCHRONIZATION** list – selects synchronization (external or internal)
- **Input delay** – sets the delay between current pulses of PDD and the synchronization pulses
- **Output delay** – sets the delay between synchro output and current pulses of PDD
- **CONTROL** list – defines behavior of the driver in Stand-alone mode
- **SAVE TO EEPROM** button – saves all driver's parameters to EEPROM
- **Device state** – shows essential information about the driver

TEC section:

- **Set temperature** – temperature set point (10 – 60 °C)
- **Stabilization timeout** – sets stabilization timeout (0 to infinite timeout)
- **Peltier resistance** – sets Peltier resistance (recommended for better performance)
- **Temperature monitor** – real temperature measured with NTC
- **Temperature monitor (AUX)** – temperature measured with NTC-AUX
- **TEC state** – status of TEC
- **ON/OFF** button – starts/stops TEC

PCD (Pockels cell driver) section:

- **HV pulse amplitude** – sets pulse amplitude (2000 – 4000 V)
- **Pulse delay** – sets pulse delay relatively to the start of current pulse
- **Voltage monitor** – DC buffer voltage of the Pockels cell driver
- **ON/OFF** button – enables/disables Pockels cell driver

Charger section:

- **Buffer voltage** – sets buffer voltage (DC input of the diode driver)
- **Voltage monitor** – buffer voltage of the diode driver
- **ON/OFF** button – enables/disables capacitor charger

PDD (pulsed diode driver) section:

- **Output current** – sets pulse current (15 – 150 A)
- **Pulse width** – sets pulse width (50 – 300 us)
- **Pulse frequency** – sets repetition rate (1 – 30 Hz)
- **Pulse counter** – pulse counter
- **RESET** button – resets pulse counter
- **ON/OFF** button – starts/stops diode driver

RS-485 (RS-232) protocol description

RS-232 / RS-485 connection parameters: 38400 bps, 8 data bits, 1 stop bit, no parity.

Command format is: {command} {data (optionally)} {end-of-line}

- data is ASCII-string of adjusting value
- end-of-line symbols are `\r\n` or `\n`

Example: “tt 25.1” sets the temperature of TEC to 25.1 °C.

List of available commands:

Common commands:

- * – Returns firmware version
- e – Turns on/off echoing of symbols in RS-232 (turned on by default)
- E – Returns echoing status
- SM – Saves all the parameters to EEPROM
- RM – Clears EEPROM (resets all the parameters, including calibration data, to the default values; driver’s restart is required after reset)
- ec – Clears error code (‘ec 0’ to clear error code)
- EC – Returns error code:
 - 0 – no error
 - 1 – IDC
 - 2 – common fault
 - 3 – charger overheat
 - 4 – IGBT overheat
 - 5 – overvoltage (buffer voltage too high)
 - 6 – temperature stabilization fault
- mc – Sets the source of Voltage, Current and Temperature in Stand-alone mode (‘mc 1’ – buffer voltage, pulse current and TEC temperature are set by the corresponding trim pots, ‘mc 0’ – by the parameters set in the device’s memory)
- MC – Returns the source of Voltage, Current and Temperature
- GC – Returns pulse counter
- RC – Resets pulse counter

Buffer voltage (charger) related commands:

- cr – Turns the capacitor charging module on and off (‘cr 1’ turns on, ‘cr 0’ turns off)
- cR – Returns capacitor charging module set point
- cv – Sets the desired buffer voltage (in Volts, from V_{MIN} to V_{MAX})
- cV – Returns buffer voltage set point
- cmV – Returns voltage monitor (actual voltage measured by internal monitor)

Diode driver related commands:

- dr – Starts/stops current pulses (‘dr 1’ starts pulses, ‘dr 0’ stops pulses)
- dR – Returns run status
- di – Sets diode current (in Amperes, from I_{MIN} to I_{MAX})
- dI – Returns diode current set point
- dp – Sets pulse length (in microseconds, from P_{MIN} to P_{MAX})
- dP – Returns pulse length set point
- df – Sets pulse repetition rate (in Hertz, from F_{MIN} to F_{MAX})
- dF – Returns pulse repetition rate set point

TEC related commands:

- tr – Starts/stops TEC (‘tr 1’ starts, ‘tr 0’ stops)
- tR – Returns the actual state of the TEC
- tt – Sets temperature set point (in Celsius degrees, from T_{MIN} to T_{MAX} , basing on 10K NTC thermistor MF52C1103F3380 R/T curve)
- tT – Returns temperature set point

tC – Returns the actual temperature (temperature monitor, basing on 10K NTC thermistor MF52C1103F3380 R/T curve)
 taC – Returns the actual temperature of auxiliary NTC (NTC-AUX pins of TEC connector)
 ts – Sets TEC waiting time (in seconds, from W_{MIN} to W_{MAX} , if temperature isn't stabilized within this time, this is considered as a fault, 'ts 0' means infinite TEC waiting time)
 tS – Returns TEC waiting time set point
 tpr – Sets Peltier resistance (in Ohms, from R_{MIN} to R_{MAX} , correct setting is recommended for better PID regulation)
 tpR – Returns Peltier resistance set point

PCD related commands:

qr – Enables/disables Pockels cell driver ('qr 1' – enables, 'qr 0' – disables)
 qR – Returns status of Pockels cell driver
 qv – Sets output voltage (in Volts, from HV_{MIN} to HV_{MAX})
 qV – Returns output voltage set point
 qmV – Returns voltage monitor (actual voltage measured by internal monitor)

Synchronizations:

s – Sets synchronization mode ('s 0' – external synchronization mode, 's 1' – internal synchronization mode)
 S – Returns synchronization mode
 ~i – (in external synchronization mode) Sets delay between diode current pulse and the external synchronization pulse
 ~I – (in external synchronization mode) Returns delay between diode current pulse and the external synchronization pulse
 ~o – (in all modes) Sets delay between synchro output and diode current pulse
 ~O – (in all modes) Returns delay between synchro output and diode current pulse
 ~q – (in all modes) Sets delay between HV pulse and diode current pulse
 ~Q – (in all modes) Returns delay between HV pulse and diode current pulse

Typical preset parameters (may vary for different versions of the product):

Parameter	Min	Max	Step	Default
cv	6	33	0.1	15
di	15	150	1	50
dp	50	300	1	100
df	0	30	0.01	5
tt	10	60	0.1	25
ts	0	180	1	30
tpr	0	5	0.01	1
qv	2000	4000	1	3600
~i	0	1000	1	0
~o	-1000 *	1000	1	0
~q	-1000 **	1000	1	100

* negative delays are possible while $\sim i + \sim o > 0$

** negative delays are possible while $\sim i + \sim q > 0$