

HVSW-03
high voltage high repetition rate
Pockels cell driver
with embedded power supply

User manual

Warning! This equipment produces high voltages that can be very dangerous. Please read user manual before starting operations.

Important note: please measure the output with symmetrical (differential) high voltage probe only. Measurement made with inappropriate equipment is a common cause of driver's failure.



Table of content

Table of content	2
Description.....	3
Connectors, pins, interface signals	4
Safety.....	6
Operations (analogue interface)	7
RS-485 interface description	7
Software description	8
Technical notes	10
Specifications	11
Dimensions	12
Performance, output oscillograms	13
Appendix A. RS-485 communicative protocol	14

Description

HVSW-03 is a specialized Pockels cell driver that performance is optimized for pico- and femtosecond lasers. Main applications are pulse picking and regenerative amplifier control.

Maximal output voltage is 2kV; maximal repetition rate achieves 1MHz at 1.5kV output voltage. Modification with performance of 2MHz at <1.0kV output voltage is available on request.

Transition times are as fast as 5-7ns in dependence on load capacitance and driver's configuration (see also *Software description* section). Pulse width is <15ns (fixed), then 100-2000ns (adjustable by the customer), see also *Software description* section.

Interfaces are analogue and RS-485. Configuration software for Windows® 7 is available.

Compact design (about 0.3dm³), conductive cooling through the bottom surface and embedded high voltage power supply (i.e. driver's input is +24V DC) are additional benefits.



Connectors, pins, interface signals

INTERFACE (D-SUB mixed contact connector FM11W1):

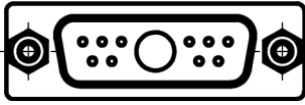

PIN (color)	DESIGNATION	DESCRIPTION
1 (yellow)	HV Program	Analogue voltage applied to this pin defines the amplitude of high voltage pulses at driver's output. 0V on this pin corresponds to 0V at the output. 2V on this pin corresponds to 2kV at the output (calibration 1:1000).
2, 10 (black)	GND (analogue interface, RS-485)	Return of Interface signals (HV Program, HV Enable, Pulse, Gate Limit Fault, Overtemp Fault). Grounding of RS-485 interface to be used in the case of high level of EMI affecting quality of RS-485 connection and the need to equalize the potentials of receiver and transmitter.
3 (black, thick wire)	+24V DC Return	+24V DC power supply negative
4 (red)	Overtemp Fault	In the case of overheating driver sets up the fault on this pin (TTL high – fault, low – no fault) and stops the operations till fault reason is eliminated and driver is rebooted (disabled and enabled again).
5 (blue)	HV Enable	+5V applied to this pin turns on embedded high voltage power supply and enables the output. This pin is also used to reboot the driver in the case of overheating and other faults. To remove overtemp fault state driver should be disabled and enabled again.
6 (orange)	Gate limit Fault	Gate limit is a hardware protection of laser optics from too long pulses applied to the Pockels cell controlling the regenerative amplifier. If pulse width applied to Pulse pin (A1) exceeds Gate limit value driver forcibly cuts off the pulse and sets up the Gate limit Fault (TTL high – fault, low – no fault). Despite the Fault state driver continues the operations. To remove state driver should be disabled and enabled again.
7 (violet)	RS-485 «+»	RS-485 «+» to be applied here
8 (green)	RS-485 «-»	RS-485 «-» to be applied here

9 (red, thick wire)	+24V DC	+24V DC power supply positive. Rated current – 5.5A max.
A1 (black)	Pulse	<p>In Fixed pulse width mode (see also <i>Software description</i> section):</p> <p>TTL signal applied to this pin initiates HV pulse at driver's output. Rising edge triggered. Trigger level is 3V. HV pulse width is fixed and <15ns.</p> <p>In Variable pulse width mode (see also <i>Software description</i> section):</p> <p>Driver's output repeats TTL signal applied to this pin. Minimal pulse width is 100ns, maximal pulse width is 2000ns or Gate limit (what's less). Minimal inter-pulse interval is 100ns.</p> <p>Input impedance is 50Ohm.</p> <p>Signal amplitude delivered to the switch should be +5V DC assuming divider of switch's input impedance and pulse generator output impedance.</p>

HV OUTPUT (flying leads):

Two wires, each of 70mm length

Other wire's length and termination are available on request. Shielded output wires reducing EMI, but slightly decreasing the performance are available on request.

LEDs:

POWER (**green**) – LED lits steadily while device is powered.

RS485 (**red**) – LED is lit steady when device is in stand-alone mode (analog interface is enabled), and blinks when device is being controlled via RS-485. In bootloader (update) mode this LED makes double blinks.

STATE (**blue**) – LED blinks slowly when device is in stand-by mode; it blinks fast when error (overheat) is detected; and it is lit steady when HV output is enabled.

MOUNTING AND GROUNDING:

Driver to be mounted with 3pcs M4 screws (recommended screws are DIN 912, M4x10 or longer).

Grounding policy

Interface signals and interface return are insulated from +24VDC, HV output and coverage case. +24VDC positive and negative are insulated from Interface, HV output and coverage case. HV output electrical potentials are switched relatively potential of the coverage case.

Neither HV output positive nor HV output negative can be grounded in any way. Grounding of HV output e.g. while measuring the output with oscilloscope is a common reason of driver's failure.

Other grounding policies are available on request.

COOLING:

Driver is conductively cooled through the bottom surface, which in dependence on actual heat dissipation should be attached either to massive chassis, or to heat sink or to cold plate of the appropriate performance.

For better heat removal thermal grease or equivalent may be used.

Safety

Warning! This equipment produces high voltages that can be very dangerous. Don't be careless around the equipment.

Assemble the entire setup before powering the device.

- Avoid casual contacts of personnel with output cables and with the load
- Do not connect / disconnect output cables while driver is turned on
- Do not operate with disconnected load
- Do not turn the driver on if it was already damaged with water, chemicals, mechanical or electrical shock
- Do not self-repair the driver, there are no user-serviceable parts inside
- Driver's input-to-output insulation isn't a safety feature, but just functional one, so we highly recommend to use low voltage power supply with input-to-output insulation providing appropriate level of protection (4000VAC or 2500VAC in dependence on your application)

Operations (analogue interface)

[Pre-configuration, optional]

1. Connect +24V DC power supply to the driver, connect driver to PC (or to another controlling device)
2. Run provided Windows® software (or terminal software)
3. Configure the driver using provided Windows® software (or using RS-485 commands)
4. Disconnect the driver from PC (from another controlling device)

[Operations]

1. Attach driver to the cool plate (another cooling device)
2. Connect +24V DC power supply, Pockels cell and pulse generator to the driver. Do not apply +24V DC power before the entire setup is completely assembled
3. Turn on +24V DC power supply to power up the driver
4. Apply HV Program (pin 1) analogue voltage corresponding to the desired output voltage
5. Enable the driver using HV Enable signal (pin 5)
6. Apply Pulse signal (pin A1) with the desired pulse width and repetition rate

Important note: that's impossible to command the driver via RS-485 interface and via analogue interface at the same time. Once RS-485 connection is established, driver ignores signals applied to the analogue interface.

To switch driver from RS-485 interface to the analogue interface (or vice versa), power should be removed from the driver and then applied again.

RS-485 interface description

RS-485 connection parameters: 57600 bps, 8 data bits, 1 stop bit, no parity.

Default protocol is described in Appendix A.

Simplified protocols are available on request.

Software description

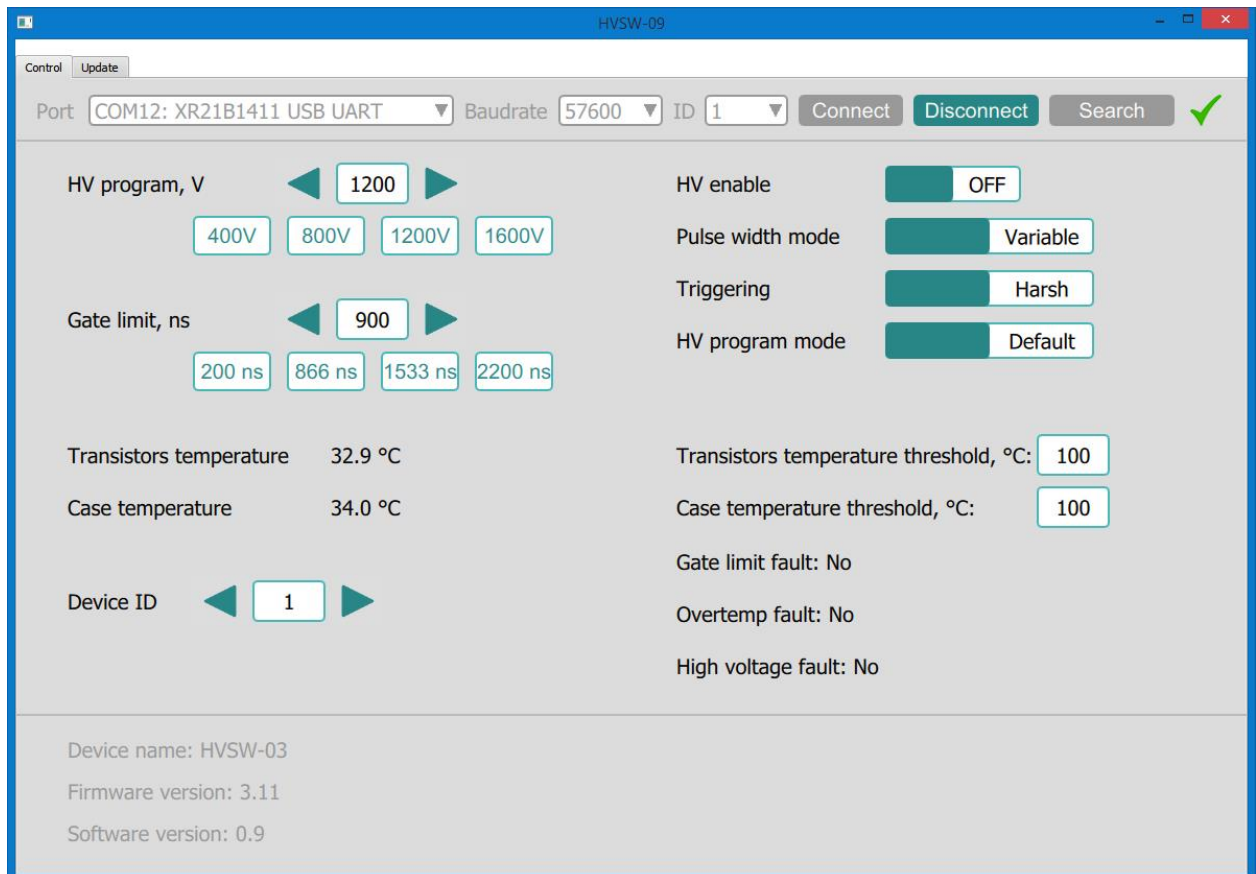

HV program – defines the amplitude of HV pulses (volts), 0V to 2000V, **default value 1500V**

HV enable – enables the driver's output

Gate limit – defines the maximal allowed pulse width (ns), 200ns to 2200ns, **default value 2200ns**

Pulse width mode (Fixed) – in this mode driver produces pulses of fixed pulse width (approximately 15ns)

Pulse width mode (**Variable**) – in this mode driver repeats incoming TTL signal (Pulse, A1 pin) at its output, i.e. produces pulse of variable pulse width

Triggering (**Soft**) – in this mode the switching of transistors is “soft” – this leads to a little bit longer risetime and falltime, but the overshoot is smaller and power consumptions (so the internal temperature) is less

Triggering (**Harsh**) – in this mode the switching of transistors is “harsh” – this results in a little bit shorter risetime and falltime, but the overshoot is higher and power consumptions (so the internal temperature) is higher

HV program mode (**Default**) – driver needs HV Program signal for operations via analogue interface

HV program mode (**Smart**) – driver doesn't need HV Program signal for operations via analogue interface (driver uses HV program value set via software or RS-485 commands; although HV Program signal, if applied, overrides the preset value)

Device ID (**“1” by default**) – driver's ID on RS-485 bus (different ID should be assigned to different drivers if a few drivers connected to the same RS-485 bus)

Transistor temperature threshold – maximal value 100 °C, default value 100 °C
Case temperature threshold – maximal value 100 °C, default value 70 °C

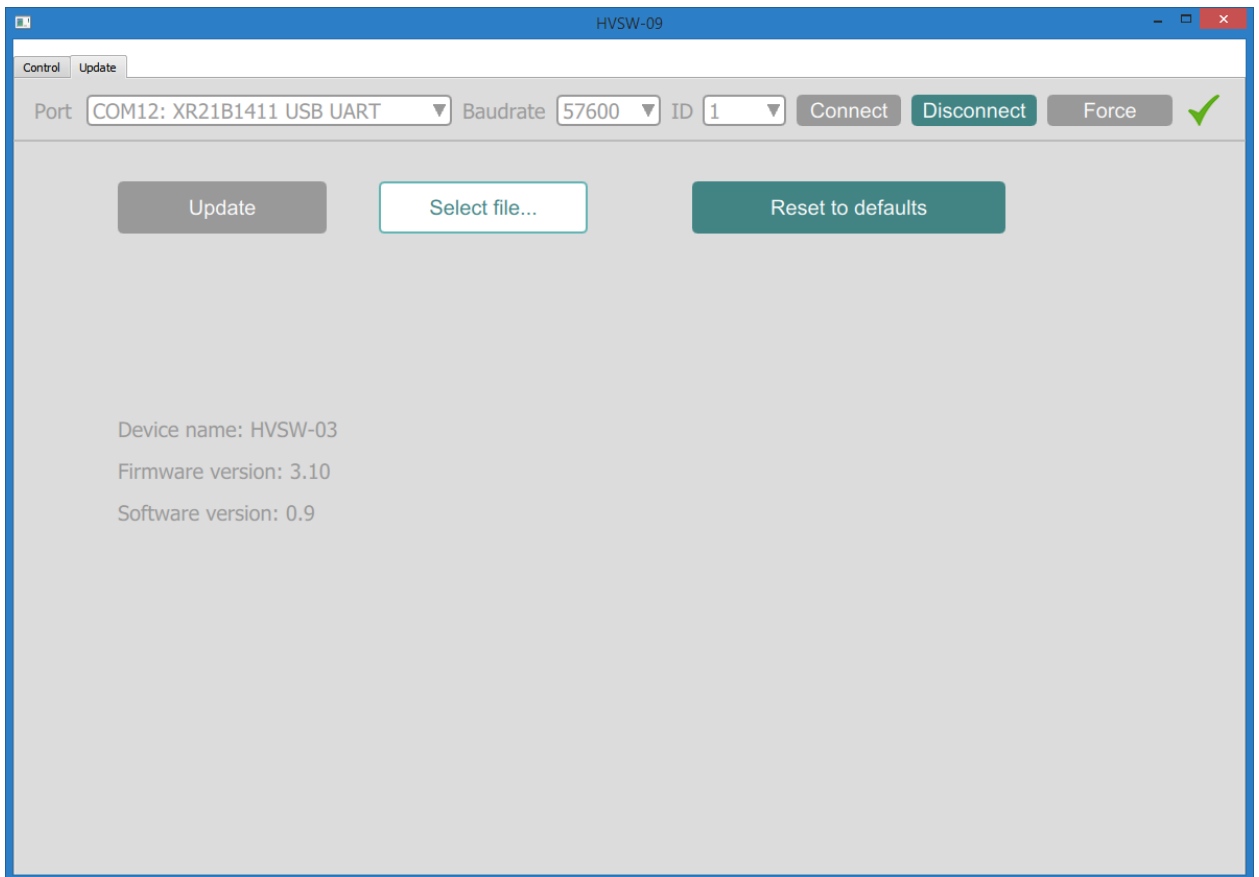

Technical notes

- **Performance of the module greatly depends on load capacitance.** Full performance is achievable at load capacitance typical to Pockels cells used in laser industry (5-7pF).

Higher load capacitance decreases maximal allowed repetition rate

- **Module's output is bipolar.** This means that e.g. 2kV pulse is physically formed by applying +1kV to one output wire and -1kV to another (see figure)

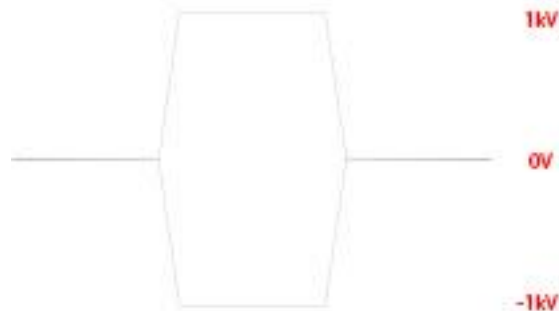

Nevertheless, all descriptions of HV output are given in terms of voltage differences. Please keep this in mind!

- **Sequential pulses have reversed polarity.** Since driver is built on full bridge schema, each of two output wires varies its potential between +V and -V values (blue and yellow curves below). As a result, the voltage difference between two wires can be both positive and negative (red curve on the picture below).

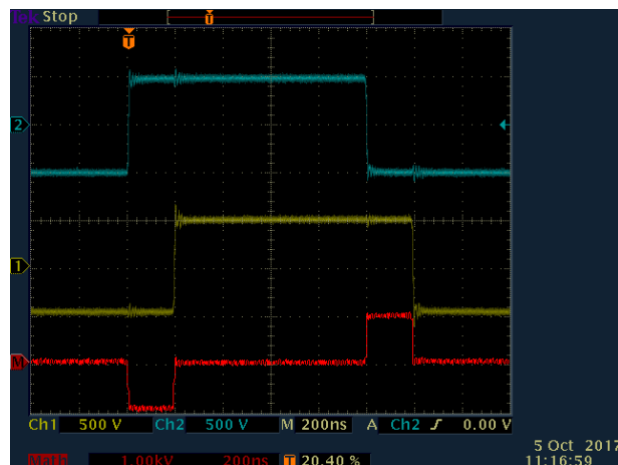

- **Arbitrary (random) signal applied to Pulse pin may damage the driver.** Please ensure Pulse signal follows the next rules:
 - Minimal allowed pulse width is 100ns
 - Maximal allowed pulse width is 2000ns
 - Minimal allowed distance between pulses is 100ns
 - Maximal allowed distance between pulses - no limitation
 - Maximal allowed repetition rate is 1MHz for standard drivers and 2MHz for high repetition rate modification.

Not every point above has the corresponding hardware protection. Please ensure the applied signals are within the allowed ranges.

Specifications

ELECTRICAL SPECIFICATION

Input	+24V DC; 5.5A max
Output	Pulses of high voltage and high repetition rate delivered to the capacitive load (e.g. to the Pockels cell)
Output type	Bipolar (see also <i>Technical notes</i> section)
Pulse basement ¹	0V, fixed
Pulse amplitude ^{1, 2}	adjustable in 0-2kV range
Maximal repetition rate ²	Up to 1-2MHz (see also <i>How to order</i> section)
Minimal repetition rate	Single shot (there is an internal restriking circuit which makes the operations at such a low repetition rate possible)
Pulse width	Fixed, about 15ns in Fixed pulse width mode (see also <i>Software description</i> section) 100ns-2000ns adjustable (other on request) in Variable pulse width mode (see also <i>Software description</i> section)
Interpulse interval	>100ns
Risetime/falltime ³	5-7ns
Delay time	<50ns
Jitter	<0.5ns (± 250 ps)
Load capacitance	5-7pF typically
Protections	- From too long pulses (Gate limit), adjusted by the customer in 200ns to 2200ns range ³ - From overheating
Environment	
Operation temperature	+10...+40 °C
Storage temperature	-20...+60 °C
Humidity	90%, non-condensing

¹ In terms of bipolar output (see also *Technical notes* section)

² Maximal pulse repetition rate depends on pulse amplitude, pulse amplitude and pulse repetition rate cannot achieve their maximums at the same time

³ 10-90% level, warranted at load capacitance 11pF and below

⁴ These and other parameters might be changed upon request

MECHANICAL SPECIFICATION

Size (LxWxH)	169x60x32mm
Weight	<0,5kg

Dimensions

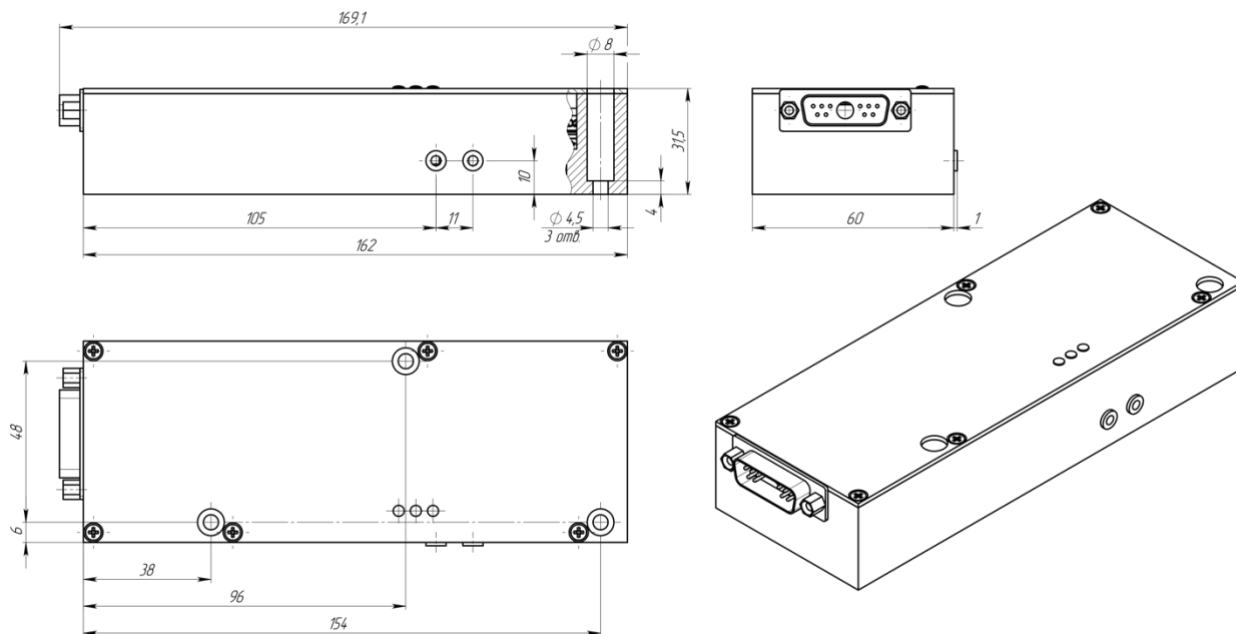

How to order?

At the moment there are two modifications different with maximal repetition rate and risetime/falltime:

Modification	Maximal repetition rate	Risetime/falltime
HVSW-03 (standard modification)	1MHz (can be damaged if operated at higher repetition rate)	5-7ns
HVSW-03-HF (high repetition rate modification)	2MHz (can be damaged if operated at higher repetition rate)	6-8ns (approx. 1ns slower than in standard modification)

Performance, output oscillograms

Driver's performance (i.e. the maximal possible repetition rate) depends on load capacitance, pulse amplitude and the performance of cooling system and limited with internal temperature (we do not recommend to exceed 80-90 °C transistor temperature) and the current consumption (we do not recommend to exceed 5A current consumption).

Performance in some typical regimes is given below:

Standard modification, ~6pF load capacitance, 2.0kV output voltage, 0.6MHz repetition rate -> cool plate temperature ~25 °C, transistor temperature ~80 °C, current consumption ~5A

Standard modification, ~6pF load capacitance, 1.5kV output voltage, 1MHz repetition rate -> cool plate temperature ~25 °C, transistor temperature ~80 °C, current consumption ~5A

High repetition rate modification, ~6pF load capacitance, 1.0kV output voltage, 1.8MHz repetition rate -> cool plate temperature ~25 °C, transistor temperature ~80 °C, current consumption ~5A

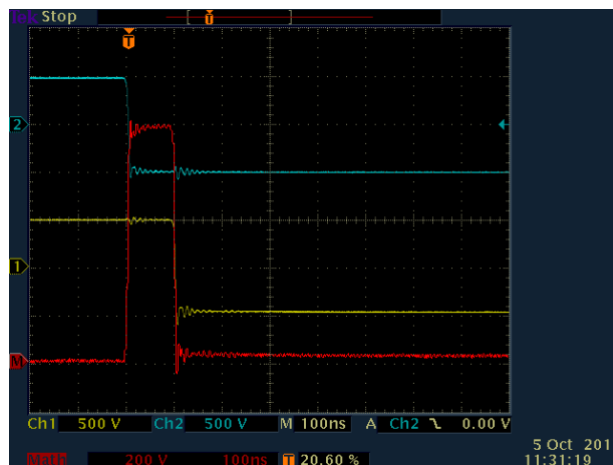

Pulse width mode - variable

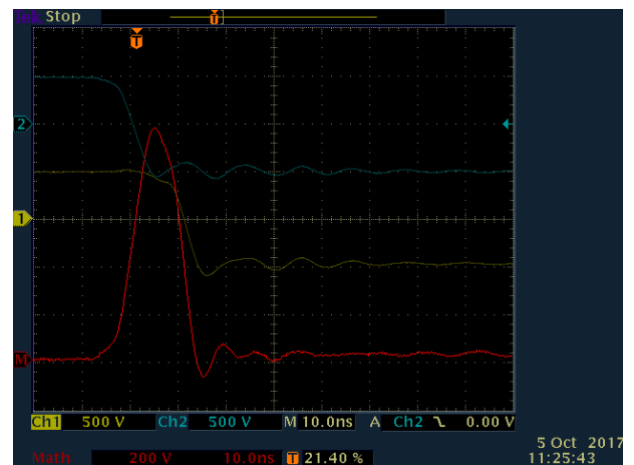

Pulse width mode - fixed

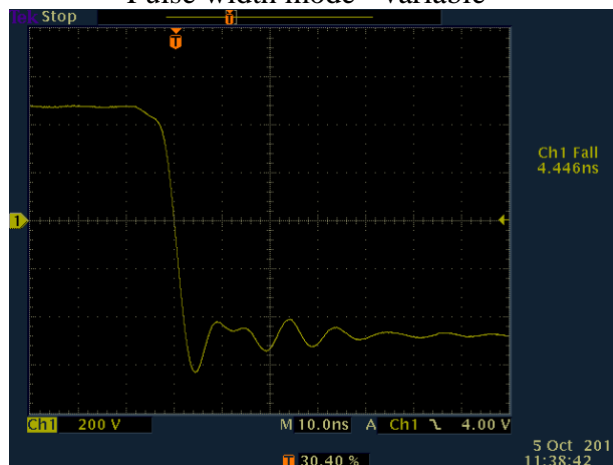

Triggering - harsh

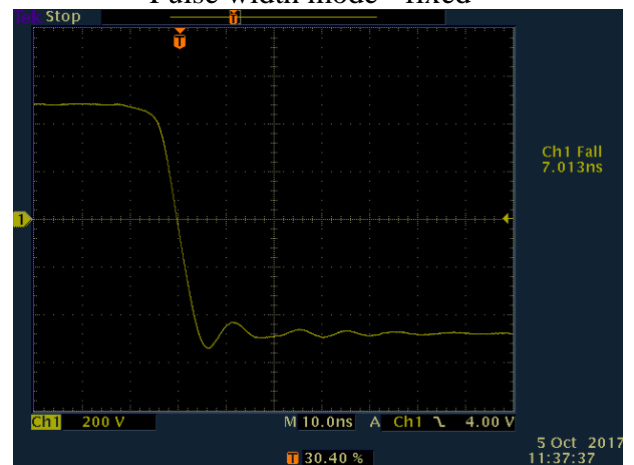

Triggering - soft

Appendix A. RS-485 communicative protocol

The present section describes RS-485, binary, master-slave protocol. Only one active master (at the same time) can be connected to the bus, and one or several (up to 254) slave nodes can be connected to the same bus. HVSW-03 is a slave device and responds to the transactions initiated by the master. Each slave device has an unique address between 1 and 254 decimal and also recognizes the broadcast address 0. Available bus baudrates for device are: 4800, 9600, 19200, 38400, 57600 (default), 115200. Available baudrate for bootloader: 57600.

Data packet format from the master:

Byte	Description
0	Synchronization/flags. 1 byte in format: 1 0 1 0 S W R M <i>M: Master bit (1 – packet is sent by the master, 0 – by slave)</i> <i>R: Retransmit bit (1 – Retransmitted packet, 0 – Normal packet)</i> <i>W: Write bit (1 – request sends data, 0 – request asks data)</i> <i>S: Sequel bit (0 – last/only packet, 1 – indicates that a further packet(s) are to be expected)</i>
1	Length of the data field. 1 byte (0 - no data; 1... 255 – data length)
2	Device ID. 1 byte (1..254, 0 indicates broadcast transmission)
3	Parameter (or Function) 0x00 ... 0x3F: common parameters 0x40 ... 0xFF: device specific parameters
4	Data field (optional). 0..255 bytes, least significant byte first. <i>Transmitting more than 255 bytes is possible by splitting up the data field in a sequence of packet transmissions by the use of the S Bit of the synchronization and flags byte.</i>
4+Length	CRC8 ITU-T (polynomial $x^8+x^2+x+1 / 0x07$) over all bytes

A slave uses the frame format described below with the same synchronization and flag byte as the master.

Byte	Description
0	Synchronization/flags: 1 0 1 0 S W R M (see flags description in master section)
1	Length of the data field. 1 byte (0 - no data; 1... 255 – data length)
2	Result, 1 byte: 0x00 ≡ no error 0x01 ... 0x7F ≡ common errors 0x80 ... 0xFF ≡ device specific errors Common errors: 0x01 <i>Parameter/Function not available</i> 0x02 <i>Parameter is read only</i> 0x03 <i>Request packet has an invalid amount of data</i> 0x04 <i>Value transmitted in the request packet is out of range</i> 0x05 <i>Current request cannot be processed at the moment</i>
3	Data field (optional). 0..255 bytes, least significant byte first
3+Length	CRC8 ITU-T (polynomial $x^8+x^2+x+1 / 0x07$) over all bytes

A slave responds message in less than 50ms after receiving a fully initiating a transaction from a master. Master must generate a time out at least 100ms after finishing a transaction.

Common parameters / functions

0x00: Ping (read only), data length: 0 byte. A slave answers by sending a packet with no data.
0x01: Device ID (write only), data length: 1 byte, range: 1..254, default value: 1. Function sets the new device ID, which is used immediately after this write request.

0x02: Protocol version (read only), data length: 1 byte, range: 1..254. A slave returns value 1.

0x03: Device part number (read/write), data length: 2 bytes, range: 0..65535. Function sets/returns device part number.

0x04: Device serial number (read/write), data length: 2 bytes, range: 0..65535. Function sets/returns device serial number.

0x05: Hardware version (read/write), data length: 2 bytes, range: 0..65535. Function sets/returns device hardware version.

0x06: Software version (read only), data length: 2 bytes, range: 0..65535. Function returns device software version.

0x07: Device string (read only), data length: arbitrary, ASCII string. Function returns device name or description.

0x08: Bootloader control and status (read or write), data length: 1 byte, data format: bit field. Function controls the bootloader using the following format:

Write request:

Bit 0: *Activate bootloader*

Bit 1: *Clear memory*

Bit 2: *Boot application*

Read request:

Bit 0: *Bootloader running (1 – yes, 0 – no)*

Bit 1: *Memory cleared (1 – yes, 0 – no)*

Bit 2: *Valid application in memory (1 – yes, 0 – no)*

0x09: Bootloader Stream (write only), data length: N packets of 1..255 bytes.

0x0A: Device status (read only), data length: 2 bytes, data format: bit field. Function returns device status in the following format:

Bit 0: *At least one warning is present*

Bit 1: *At least one error is present*

Bit 3: *Bootloader is active*

Bit 4: *Device is ready*

Bit 7: *Device is “On”*

0x0B: Available bus speed (read only), data length: 2 bytes, data format: bit field. Indicates availability of device specific bus speed implementations (in Bit/s)

Bit 0: 4.800

Bit 1: 9.600

Bit 2: 19.200

Bit 3: 38.400

Bit 4: 57.600

Bit 5: 115.200

Bits 6..15: reserved

0x0C: Set bus speed (write only), data length: 2 bytes, data format: bit field. Function sets bus speed.

Bit 0: 4.800

Bit 1: 9.600

Bit 2: 19.200

Bit 3: 38.400

Bit 4: **57.600 (Default Setting)**

Bit 5: 115.200

Bits 6..15: reserved

0x0D: Bus mute (read/write), data length: 1 byte, data range: 0-1 (0 = communication is on, 1 = communication is off). Switches off the serial communication of a device until it is switched on

again using this parameter. After power on (supply voltage) device has its serial communication switched ON.

Device specific parameters / functions

0x40: High voltage (read/write), data length: 2 bytes, range: 0..2000. Sets or gets high voltage in volts.

0x41: Gate Limit (read/write), data length: 2 bytes, range: 200..2200. Sets or gets gate limit in nanoseconds.

0x42: Transistors temperature threshold (read/write), data length: 2 bytes, range: 0..1600. Sets or gets transistors temperature threshold in 0.1 °C (e.g. 800 corresponds to 80.0 °C)

0x43: Case temperature threshold (read/write), data length: 2 bytes, range: 0..1600. Sets or gets case temperature threshold in 0.1 °C (e.g. 800 corresponds to 80.0 °C)

0x44: HV enable (read/write), data length: 1 byte, range: 0 .. 1. Enables (1) or disables (0) high voltage.

0x45: Pulse width mode (read/write), data length: 1 byte, range: 0..1. Sets or gets pulse width mode (1 – fixed, 0 – variable).

0x46: Triggering mode (read/write), data length: 1 byte, range: 0..1. Sets or gets triggering mode (1 – soft, 0 – harsh).

0x47: HV Program mode (read/write), data length: 1 byte, range: 0..1. Sets or gets HV program mode (1 – smart, 0 – default).

0x60: Get sensors (read only), data length: 1 byte, range: 0..255. Returns device sensors in the following format:

Bit 0: Overtemperature error

Bit 1: Gate limit error

Bits 2-5,7: reserved

Bit 6: HV fault error

0x61: Get transistors temperature (read only), data length: 2 bytes, range: 0..1600. Returns current transistors temperature in 0.1 °C (e.g. 800 corresponds to 80.0 °C).

0x62: Get case temperature (read only), data length: 2 bytes, range: 0..1600. Returns current case temperature in 0.1 °C (e.g. 800 corresponds to 80.0 °C).

0xF2: Get all monitors (read only), data length: 5 bytes. Returns all monitors in the following format: *sensors* (1 byte), *transistors temperature* (2 bytes), *case temperature* (2 bytes).

0xF1: Get all parameters (read only), data length: 13 bytes. Returns all parameters in the following format: *high voltage* (2 bytes), *gate limit* (2 bytes), *transistors temperature threshold* (2 bytes), *case temperature threshold* (2 bytes), *sensors and states* (1 byte in the following format: Bit 0: *overtemperature error*, Bit 1: *gate limit error*, Bit 2: *high voltage enable state*, Bit 4: *pulse width mode state*, Bit 5: *triggering mode state*, Bit 6: HV fault error), *transistors temperature* (2 bytes), *case temperature* (2 bytes).

Examples:

A1 00 01 00 FC – ping device with ID = 1 (answer: A0 00 00 48)

A1 00 01 61 DC – get transistors temperature for device with ID = 1 (answer: A0 02 00 EF 00 5F – temperature is 23.9 °C)

A5 02 01 40 E8 03 EC - set high voltage to be 1000V for device with ID = 1 (no answer)